

FU-HA Cutter (JWNXM)

- **Stable gray cast iron milling with lower cutting force**

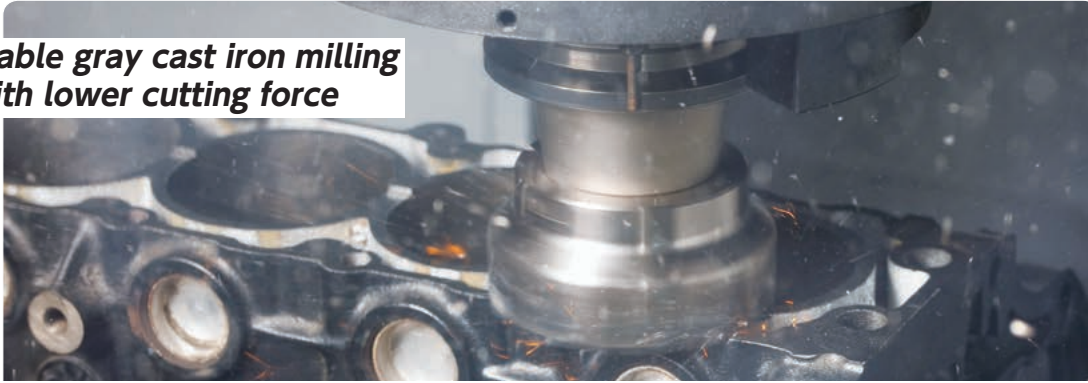

WATCH ON
YouTube

- **Maximizes ceramic insert potential and can mill faster than 1000m/min**

Thanks to lower cutting forces, work piece chipping is reduced
Apply up to A_p 6mm

Silicon Nitride grade is the best choice for roughing cast iron with scale. Tool pressure is reduced because of the sharper cutting edge and the ground-in chipbreaker



Available cutter dia. ϕ 63 - ϕ 160

Very cost efficient with a unique 6 cutting edge design

Thanks to low-cutting resistance, machine over load is avoided

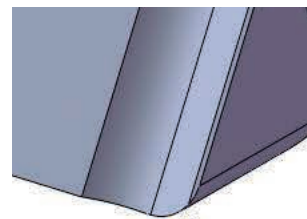
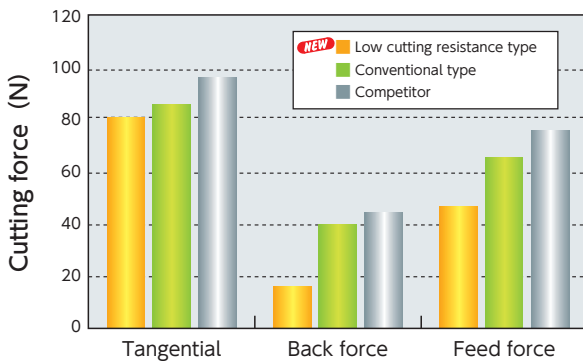

[Radius type]

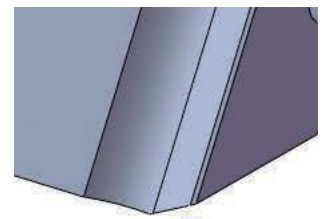

[Chamfered type]

Two edge preparation are available.
Radius type good for high feed milling.
Chamfered type with excellent edge sharpness.

**Cycle time reduction with single pass and achieve longer tool life.
Lesser machine horsepower required.**

Cutting condition

$V_c=800\text{m/min}$ $f_z=0.10\text{mm/t}$ $a_p=3.0\text{mm}$ $a_e=80.0\text{mm}$

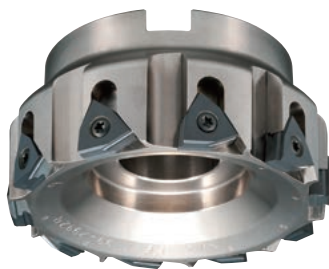

A. R. +5°
R. R. +4°, +7°, +10°

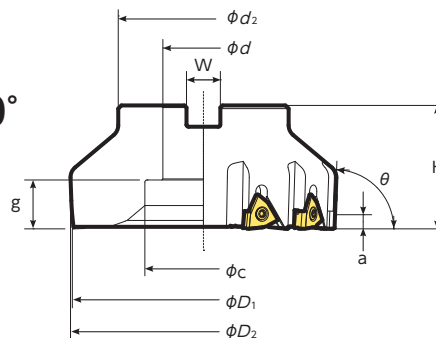
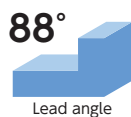

JWNXM type milling body

θ	Code No.	Part number	Stock	No of inserts	Dimensions (mm)										Weight (kg)	Rake angle (°)		Centering location type
					ϕD_1	ϕD_2	H	$a_{\ast 1}$	$a_{\ast 2}$	ϕd_1	W	ϕd_2	ϕc	g		A.R.	R.R.	
88°	QUE002327	JWNXM063-88-06R-GM	●	6	63	63	50	5.5	4.5	22	10.4	60	18	15.5	0.9	+5	+4	FMA
	QUE002823	JWNXM080-88-08R-GM	●	8	80	80				27	12.4		36	15			1.1	
	QUE002749	JWNXM100-88-10R-GM	●	10	100	100				32	14.4	80	50	18	1.8		+10	
	JWNXM125-88-12R-GM	●	12	125	125	58				40	16.4		55	23	3			
	JWNXM160-88-16R-GM	●	16	160	160	60				40	16.4	100	72	22	4.9			

※1 Dimension when set the insert [WNX44-C10T01020]
※2 Dimension when set the insert [WNX44-R12T01020]

Parts	
Clamping Screw FSI 26-4.0×12-LH 5861935 Sales quantity 10pcs/case	Wrench LLR-T15 5701909 Sales quantity 5pcs/case

Insert

Shape	Dimensions (mm)	Part number	C or r_{ϵ}	Grade	
		WNX44-C10T01020	C1.0	SX6	●
				SP9	●
		WNX44-R12T01020	R1.2	SX6	●
				SP9	●

● : New standard stock items

Recommended cutting conditions

Grade	Work material	Cutting speed (m/min)											Feed (mm/t)					Depth of cut (mm)
		400	500	600	700	800	900	1000	1100	1200	1300	1400	0.05	0.1	0.15	0.2	0.25	
SX6	Gray cast iron	[Red bar with vertical lines]											[Red bar with vertical lines]					~ 6 (mm)
		[Blue bar with vertical lines]											[Blue bar with vertical lines]					
SP9	Ductile cast iron	[Red bar with vertical lines]											[Red bar with vertical lines]					

Case study

Transmission case			● Work material : FC23		
	current tool		NTK		
Holder	Competitor		JWNXM125A3810R12		
Insert	Ceramic insert		SX6 WNX44-R12T01020		
Cutting speed	(m/min)	500	←		
Feed pertooth	(mm/t)	0.13	←		
Depth of cut	(mm)	1	←		
Coolant		DRY	←		
Tool life	(pcs/coner)	60	120		

As for competitor's milling cutter, we needed to change inserts to new ones due to the wearprogress and lower clamping force of work material after machining 60 pcs. This was caused by increasing Cutting force. NTK NEW Milling cutter "FU-HA MILL" achieved 2 times longer competitor's. Low cutting force avoided the problem occurred by competitor's milling cutter.

New Products
 Tool Materials / Selection Guide
 BIDEIMCS, PCD, CBN and Ceramics
 Micrograin Carbide, PVD Coated Carbide
 Insert Item List
 General Turning Toolholders
 Unique Swiss Tooling
 Grooving / Side Turning
 Threading
 Shaper
 ID Tooling
 Application Introduction
 Endmills
 Rotating Tools
 Information
 Index

FDX Cutter

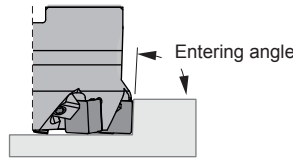
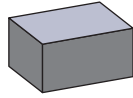

45°, 75°, 88°, 90°

Adjustable Cutter available!

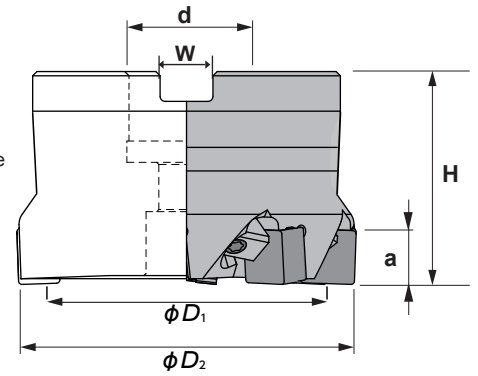

Characteristics:

Negative milling cutter with 45°, 75°, 88°, 90° entering angle. Its strong inserts accept high cutting depths and high feed per teeth. First option for cast iron milling.

Spare parts



Clamp - W6226-GM

Clamping screw- AOB-6S-T30-GM

***Will be replaced from 2020:**
WS0616-T15-GM, (QEU003866)

θ	Item number	Reference	Standard	✱	Dimensions (mm)							Weight (kg)
					φD ₁	φD ₂	H	a	φd	W	φd ₂	
45°	QEU003191	FDX050-45-05R-GM	●	5	50	58	50	8	22	10,4	45	0.78
		FDX063-45-06R-GM	●	6	63	72	50	8	22	10,4	58	0.93
	QEU003676	FDX080-45-08R-GM	●	8	80	95	50	8	27	12,4	62	1.21
		FDX100-45-10R-GM	●	10	100	120	50	8	32	14,7	62	1.66
	QEU002622	FDX125-45-13R-GM	●	13	125	146	58	8	40	16,4	83	2.80
75°	QEU000508	FDX050-75-05R-GM	●	5	50	57	50	12	22	10,4	45	0.65
	QEU000509	FDX063-75-06R-GM	●	6	63	70	50	12	22	10,4	58	0.79
	QEU000487	FDX080-75-08R-GM	●	8	80	87	50	12	27	12,4	62	1.06
	QEU000510	FDX100-75-10R-GM	●	10	100	107	50	12	32	14,7	62	1.39
	QEU000493	FDX125-75-13R-GM	●	13	125	132	58	12	40	16,4	83	2.56
		FDX160-75-16R-GM	●	16	160	166	60	12	40	16,4	100	4.1
88°	QEU000477	FDX050-88-05R-GM	●	5	50	51	50	12	22	10,4	45	0.65
	QEU000478	FDX063-88-06R-GM	●	6	63	64	50	12	22	10,4	58	0.79
	QEU000479	FDX080-88-08R-GM	●	8	80	81	50	12	27	12,4	62	1.06
	QEU000480	FDX100-88-10R-GM	●	10	100	101	50	12	32	14,7	62	1.39
	QEU000492	FDX125-88-13R-GM	●	13	125	126	58	12	40	16,4	83	2.56
	QEU000484	FDX160-88-16R-GM	●	16	160	156	60	12	40	16,4	100	4.1
90°	QEU002366	FDX050-90-05R-GM	●	5	50	50	50	12,7	22	10,4	45	0.65
	QEU000515	FDX063-90-06R-GM	●	6	63	63	50	12,7	22	10,4	58	0.79

Applicable inserts

Shape	Dimensions (mm)	Reference	R	Silicon Nitride			Whisker
				SX6	SP9	WA1	
 12.5		SNGN 120408 T00520	0.8			●	
		SNGN 120408 T02020	0.8	●	●		
		SNGN 120412 T00520	1.2			●	
		SNGN 120412 T02020	1.2	●	●		
		SNGN 120416 T00520	1.6			●	
		SNGN 120416 T02020	1.6	●	●		
 12.5 with chipbreaker		SNGF 120412 TRC-C	1.2	●	●		
 6.3 with wiper		SNGN 1204AN TW	—	●	●		
Dimensions (mm)		Reference	R	CBN			
 θ = 45°		FDX 1204-45-50R	—	●		●	

QTS Cutter

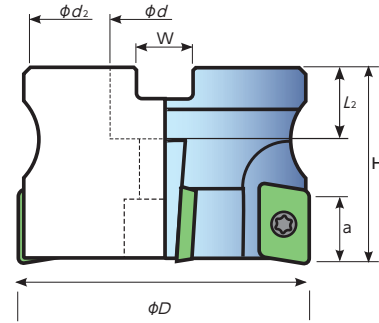
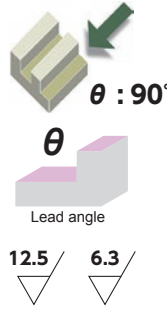

Reference	Standard	Flutes	Dimensions (mm)							Item No.	Weight (kg)	A.R.	R.R.	Insert Screw	Wrench	Insert
			ϕD	H	L_2	a	ϕd	W	ϕd_2							
QTS040-90-4R-GM	●	4	40	40	18	14	16	8.4	35	QEU000464	0.2	+6°	-13°	521673 M4x9-GM	T-15A	APCW 1604
QTS050-90-5R-GM	●	5	50	40	22	14	22	10.4	45	QEU000465	0.3	+6°	-10°			
QTS063-90-6R-GM	●	6	63	50	22	14	22	10.4	58	QEU000466	1.4	+6°	-12°			
QTS080-90-8R-GM	●	8	80	50	25	14	27	12.4	58	QEU000467	1.9	+6°	-12°			

QTE Cutter

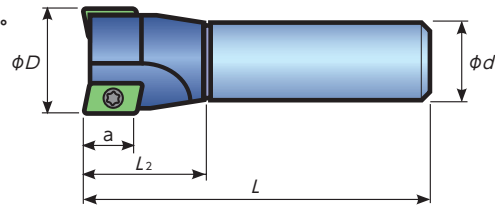
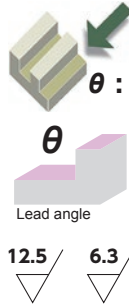

Reference	Standard	Flutes	Dimensions (mm)					Item No.	Weight (kg)	A.R.	R.R.	Insert Screw	Wrench	Insert
			ϕD	L	L_2	a	ϕd							
QTE025-90-2R-GM	●	2	25	100	30	14	25	QEU000461	0.3	+6°	-13°	521673 M4x9-GM	T-15A	APCW 1604
QTE032-90-3R-GM	●	3	32	110	35	14	32	QEU000462	0.5	+6°	-13°			
QTE040-90-4R-GM	●	4	40	110	37	14	32	QEU000463	0.6	+6°	-13°			

Inserts

Shape	Reference	R	m	Silicon Nitride	
				SX6	SP9
	APCW 160408 T01020	0.8	7.314	●	●
	APCW 160412 T01020	1.2	7.278	●	●
	APCW 160420 T01020	2.0	7.205	●	●
	APCW 1604 PDTR	—	7.163	●	●

Recommended Cutting Conditions

Work Material	Grade	Dry	Wet	Cutting Speed (m/min)								Feed (mm/t)					Depth of Cut (mm)			
				200	350	500	650	800	950	1100	1250	0.05	0.1	0.15	0.2	0.25		0.3		
K	SX6	●	○																	~ 8.0
Gray Cast Iron	SP9	●	●																	~ 8.0
Ductile Iron	SP9	●	○																	~ 8.0