

# Threading

## TTP Series

### TTP

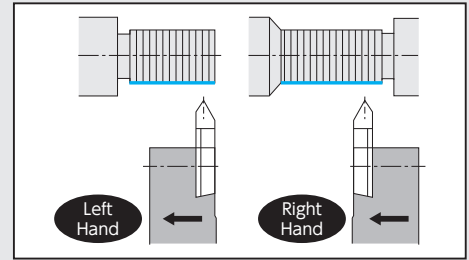
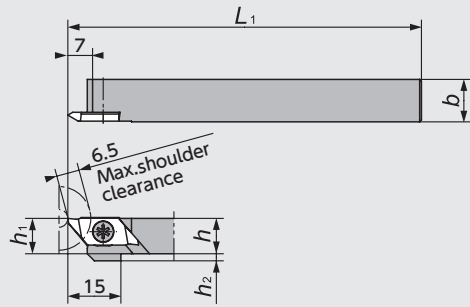

● Right-Hand style shown

Figure-1

### TTP-OH2

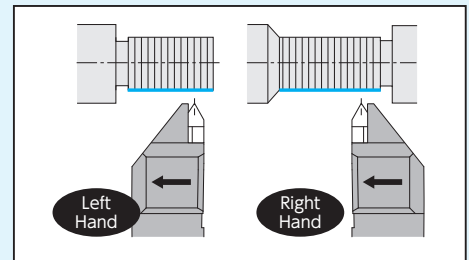
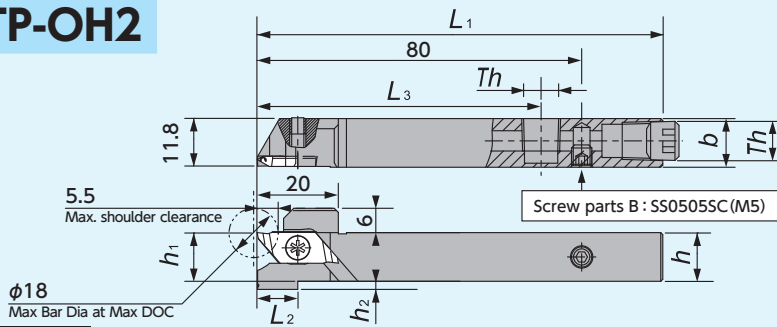

Th(screw parts [A])  
1212/1616size : SPR1/8(Rc1/8)

● Right-Hand style shown

Figure-2

### TTP-F

Shift Holder

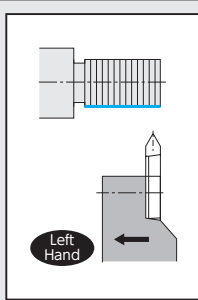
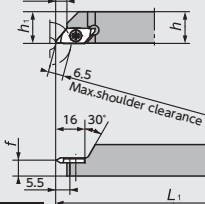

● Left-Hand style shown

Figure-3

### TTP

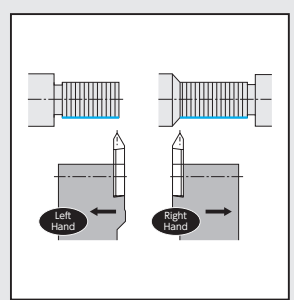
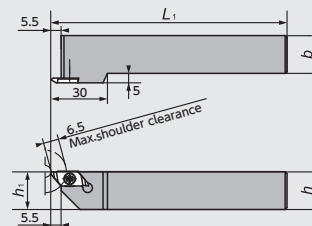

● Right-Hand style shown

Figure-4

### DS-TTP

(DS Holder)

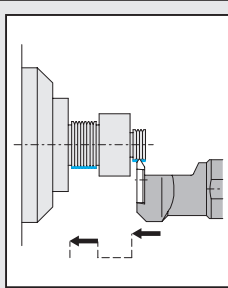
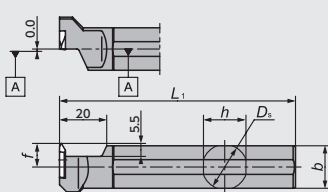

● Left-Hand style shown  
☆ Takes Right-hand insert

Figure-5

### CH-TTP

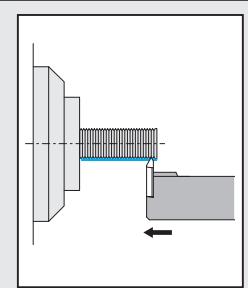
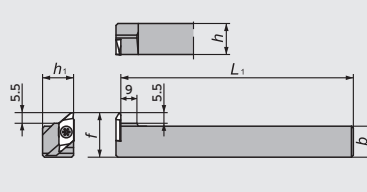

● Left-Hand style shown  
☆ Takes Right-hand insert



Figure-6

## TTP Series - Toolholders

Figure	Code No.		Item Number	Stock		Dimensions (mm)						Gage insert	Spare Parts		
	R	L		R	L	D <sub>s</sub>	h	b	L <sub>1</sub>	h <sub>1</sub>	f		h <sub>2</sub>	Clamp Screw	Wrench
1	5146238	5146220	<b>TTP</b> L08	●	●	-	8	10	120	8	-	0	TTP I 13	LRIS-4*10PW (A)	CLR-15S (A)
	5145693	5145685	<b>10</b>	●	●		10			2					
	5459854	5503024	<b>12GX</b>	●	●		12	12	85	12					
	5145701	5145719	<b>12</b>	●	●		120								
	5459862	5459870	<b>16H</b>	●	●		16	16	100	16					
	5191234	5267190	<b>16</b>	●	●		120								
5459573	5459581	<b>20F</b>	●	●	20	20	80	20				LRIS-4*10 (B)	LLR-25S-20*65 (B)		

※Compatible with 16mm / 22mm round shank DS Series holders. DS-Sleeve G103

## TTP Series - Toolholders

Figure	Code No.		Item Number	Stock		Dimensions (mm)								Gage insert 	Spare Parts		
	R	L		R	L	D <sub>s</sub>	h	b	L <sub>1</sub>	h <sub>1</sub>	f	h <sub>2</sub>	L <sub>2</sub>		L <sub>3</sub>	Clamp Screw 	Wrench 
2	5061882	5061890	TTP <sup>R/L</sup> 12H-OH2	●	●	—	12	12	100	12	—	2	10	70	TTP <b>I 13</b>	LRIS-4*12PW	CLR-15S
	5062229	5062237	TTP <sup>R/L</sup> 16X-OH2	●	●	—	16	16	120	16	—	0	—	70			
3		5978150	TTPL12-F06		●	—	12	12	120	12	6	—	—	—	TTP <sup>R/L</sup> FL <b>I 13</b>	LRIS-4*6 (B)	LLR-25S (B)
		5978168	TTPL16-F08		●	—	16	16	120	16	8	—	—	—			
4	5989959	5989942	TTP <sup>R/L</sup> 20K-25	●	●	—	20	20	125	20	—	—	—	—	TTP <sup>R/L</sup> FR <b>I 13</b>	LRIS-4*10 (B)	LLR-25S (B)
	5989975	5989967	TTP <sup>R/L</sup> 25M-30	●	●	—	25	25	150	25	—	—	—	—			
5		5782149	DS-TTP <sup>R/L</sup> 16F*		●	16.00	15	15	80	—	10.0	—	—	TTP <b>I 13</b>	LRIS-4*10 (B)	LLR-25S-20*65 (B)	
		5278270	19		●	19.05	18	18									
		5278296	20		●	20.00	19	19	120								
		5324033	22*		●	22.00	21	21									
		5830641	25MET		●	25.00	24	24	150								
		5317151	25		●	25.40	24	24	150								
6		5885090	CH-TTP <sup>R/L</sup> 16		●	—	16	16	120	16	23	—	—	TTP <sup>R/L</sup> FR <b>I 13</b>	LRIS-4*10 (B)	LLR-25S (B)	
		5885108	20		●	—	20	20	20	27	—	—	—				

\*Compatible with 16mm / 22mm round shank DS Series holders. DS-Sleeve → G103

## TTP Series - Inserts

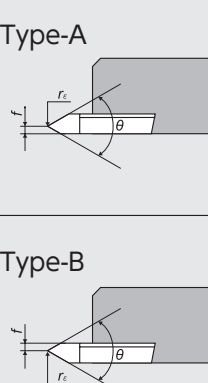
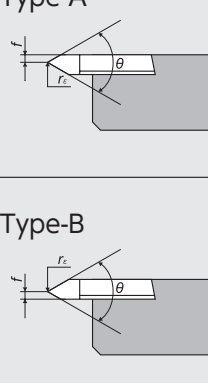
Shape	Item Number	Dimensions (mm)			Thread Type		Carbide		PVD Coated Carbide				
		θ	f	r <sub>e</sub>	Pitch	TPI	KM1	Stock	ZM3	Stock	QM3	Stock	
Right-Hand 	TTP60FR2A	60°	0.2	(0.05) MAX Flat	0.2~0.35				5892278	●			
	60FR4A								5145602	●	5234216	●	
	60FR4AS <sup>M</sup>		0.4	(R0.05)	0.4~1.25			5578158	●				
	60FR8A							5145537	●	5337340	●		
	60FR8AS <sup>M</sup>	55°				48~16			5145495	●			
	TTP55FR8A								5892302	●			
	Type-B	TTP60FR2B	60°	0.2	(0.05) MAX Flat	0.2~0.35				5892302	●		
		60FR4B								5145586	●	5601315	●
		60FR4BS <sup>M</sup>		0.4	(R0.05)	0.4~1.25			5578133	●			
		60FR8B							5145529	●	5506472	●	
		60FR8BS <sup>M</sup>	55°				48~16			5145487	●		
		TTP55FR8B								5145560	●	5474630	●
Type-N	TTP60FR-N	60°	1.25	(R0.1)	1.0~1.5				5145560	●	5474630	●	
	60FR-NS <sup>M</sup>								5578067	●			
	60FR-N02	(R0.2)	1.5~2.0					5626247	●	5626254	●		
Left-Hand 	TTP60FL2A	60°	0.2	(0.05) MAX Flat	0.2~0.35				5892286	●			
	60FL4A								5145594	●	5601307	●	
	60FL4AS <sup>M</sup>		0.4	(R0.05)	0.4~1.25			5578174	●				
	60FL8A							5145545	●	5601273	●		
	60FL8AS <sup>M</sup>	55°				48~16			5145503	●			
	TTP55FL8A								5912555	●			
	Type-B	TTP60FL2B	60°	0.2	(0.05) MAX Flat	0.2~0.35				5912555	●		
		60FL4B								5145578	●	5601299	●
		60FL4BS <sup>M</sup>		0.4	(R0.05)	0.4~1.25			5578141	●			
		60FL8B							5145511	●	5503438	●	
		60FL8BS <sup>M</sup>	55°				48~16			5145479	●		
		TTP55FL8B								5145552	●	5601265	●
	Type-N	TTP60FL-N	60°	1.25	(R0.1)	1.0~1.5				5145552	●	5601265	●
		60FL-NS <sup>M</sup>								5578083	●		
		60FL-N02	(R0.2)	1.5~2.0					5626270	●	5626262	●	